

Coastline

Transform space with light

Lacilite

Light First

Innovating lighting

Design is a key aspect of social innovation. In the lighting industry, design holds immense significance as it shapes the efficiency, aesthetics, and functionality of LED outdoor luminaires. A well-executed design can lead to innovative breakthroughs, enabling the development of cutting-edge lighting solutions that address emerging challenges and needs. It empowers lighting manufacturers to create products that offer enhanced performance, energy efficiency, and durability, ultimately driving progress and competitiveness in the industry.

Additionally, design-driven innovation in LED outdoor lighting fosters sustainable practices, reduces environmental impact, and improves overall user experiences. By embracing design as a core driver of innovation, the lighting industry can push the boundaries of what is possible, shaping the future of outdoor illumination and positively impacting society and the environment.

Laclite's mission is to leverage light to enhance the relationship between humanity and the environment, using cutting-edge research, manufacturing, technology, and knowledge.

Laclite is dedicated to serving the disciplines of architecture and light culture, with a shared goal of improving the quality of life. Through collaboration with prominent architects and lighting designers worldwide, Laclite produces sophisticated lighting systems that cater to the unique requirements of each project.

Laclite





Coastline Linear Light Series

Versatile Linear Lighting, adept at elegantly highlighting curved elements through both vertical and horizontal flexing. Minimizes unsightly scalloping light, suitable for various offset distances, applicable to both indoor and outdoor environments

Linear Lighting

Defining Architectural Spaces with Linear Lighting

Linear Lighting, pivotal for highlighting and contouring architectural spaces, traditionally required specialized optics and fixtures. The advent of linear LED technology now enables slim, efficient luminaires to expertly manage this complex, vertical or horizontal illumination both indoors and outdoors.

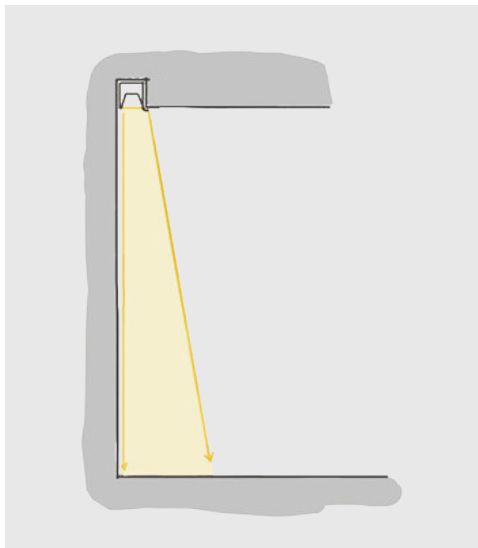

Wall Grazer

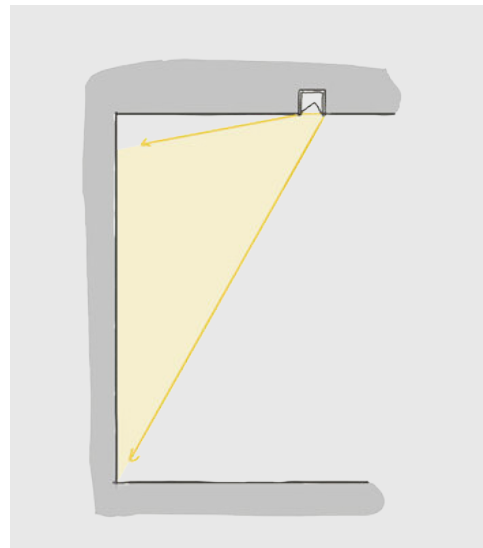

Wall Wash

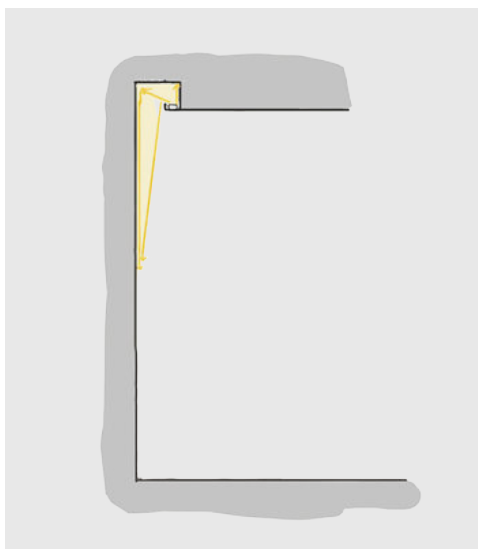

Reverse Uplight Cove

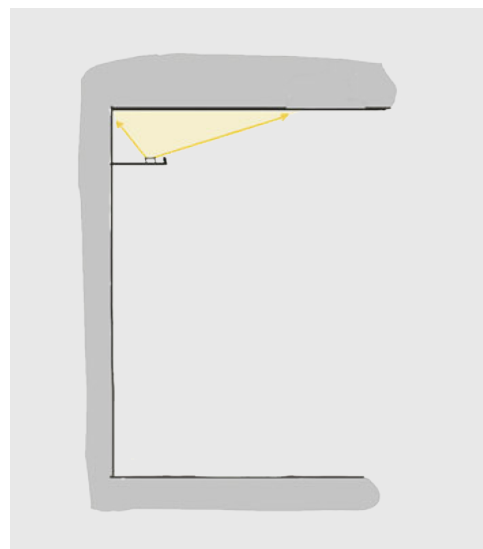

Uplight Cove

Wall Washing Lighting



P400



CL008



CL001

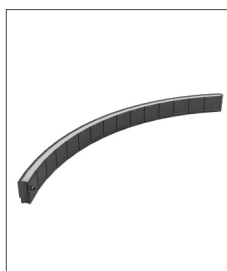

CL002



CL003



CL004

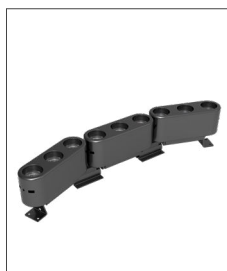

CL005



CL006



CL021



CL009

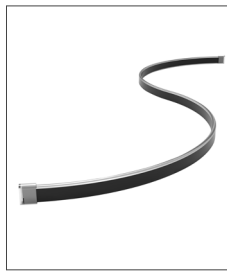

CL010

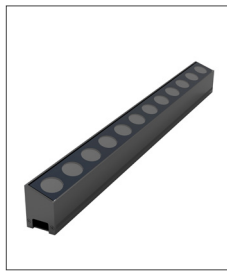

CL007



CL011

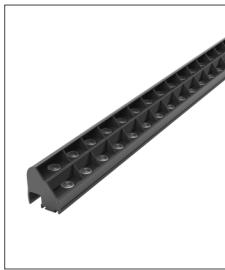

CL012



CL013



CL014



CL018



CL019



CL020

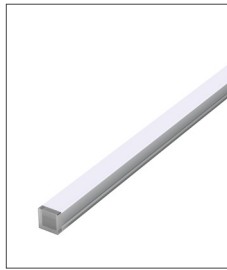

CL016



CL017



CL023

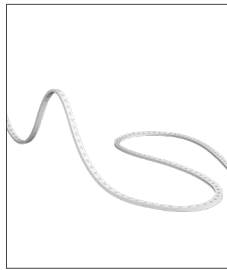

CL022

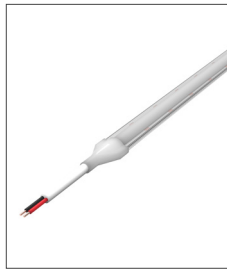

CL015



Click on the image
for more details

Color temperature

Using light colors effectively

Artistry, whether indoors or outdoors, can be influenced by the color of light used to illuminate it. Different colors can create different atmospheres and affect the perception of the environment. For example, warm colors like 2700K are suitable for materials like wood, while cool colors like 4000K are better for cooler surfaces like exposed concrete. By using light of different color temperatures, we can create unique scene lighting concepts, allowing for the design and transformation of environments with subtle or dramatic contrasts.

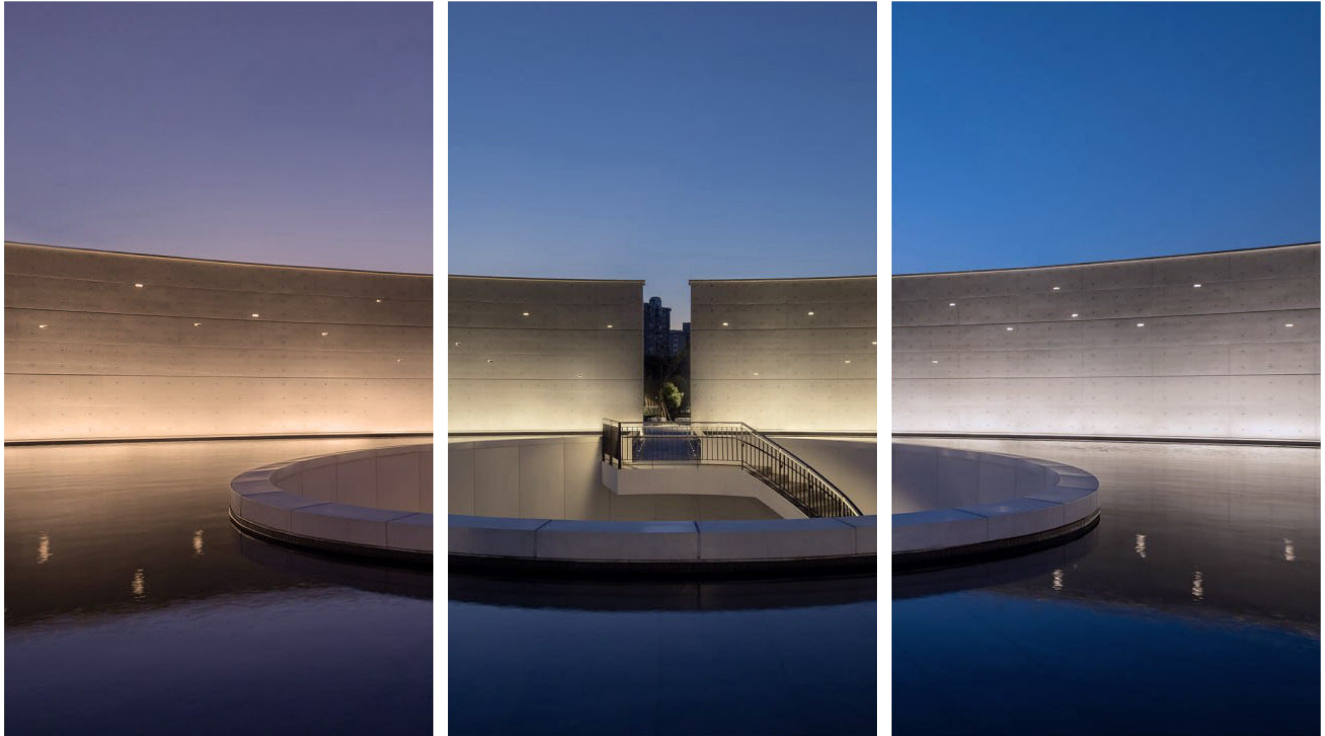

2700K

4000K



Product Details

P400 Flexible Linear Light

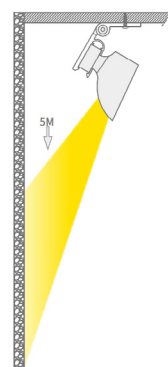
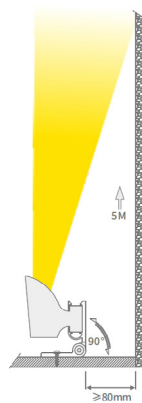
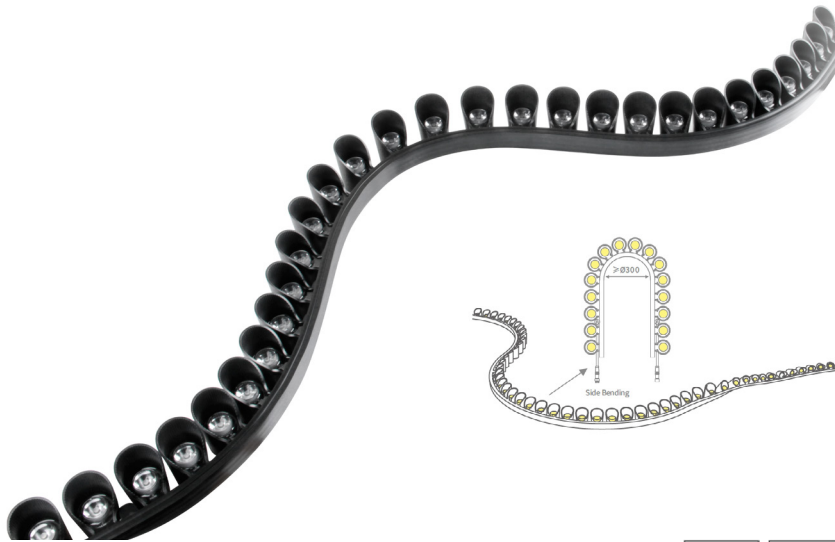

This flexible wallwasher adjusts at multiple points, achieving effects that typically require two or more fixtures, and ensuring seamless integration without obstructing HVAC systems and other ceiling utilities.

Spec guide



- Tiny size for narrow spaces
- Flexible and bendable design
- Effective wall washing
- IP67 for indoor and outdoor applications

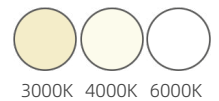
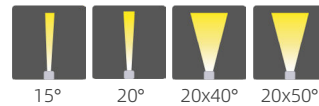
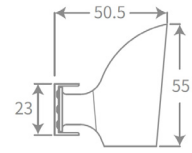
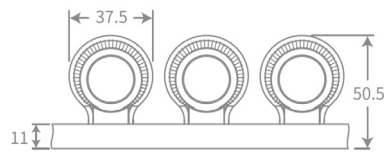

Item No.	Power	Length	Beam Angle	Lumen	Input Current
P400	11W 22W 33W 45W 90W	L=300mm L=600mm L=900mm L=1200mm L=2400mm	15° 20° 20x40° 20x50°	90 lm/W	DC24V

Light distribution curve

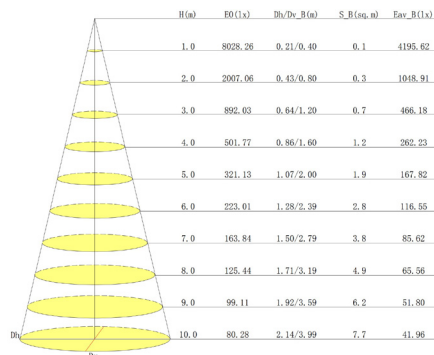
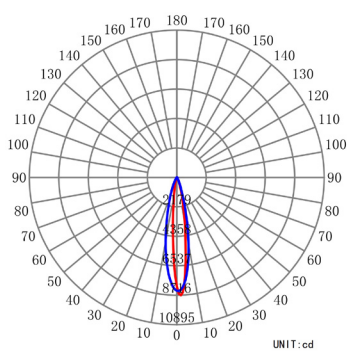

Colour temperature - CRI

- 3000K - CRI > 80
- 4000K - CRI > 80
- 6000K - CRI > 80

IP protection rating

IP67

Dimmable

- Triac
- PWM
- 0~10V
- DALI

Accessories

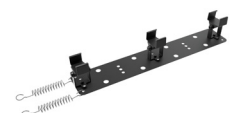

Flexible mounting clip



Turnable holder

Product Details

CL008 Flexible Linear Light

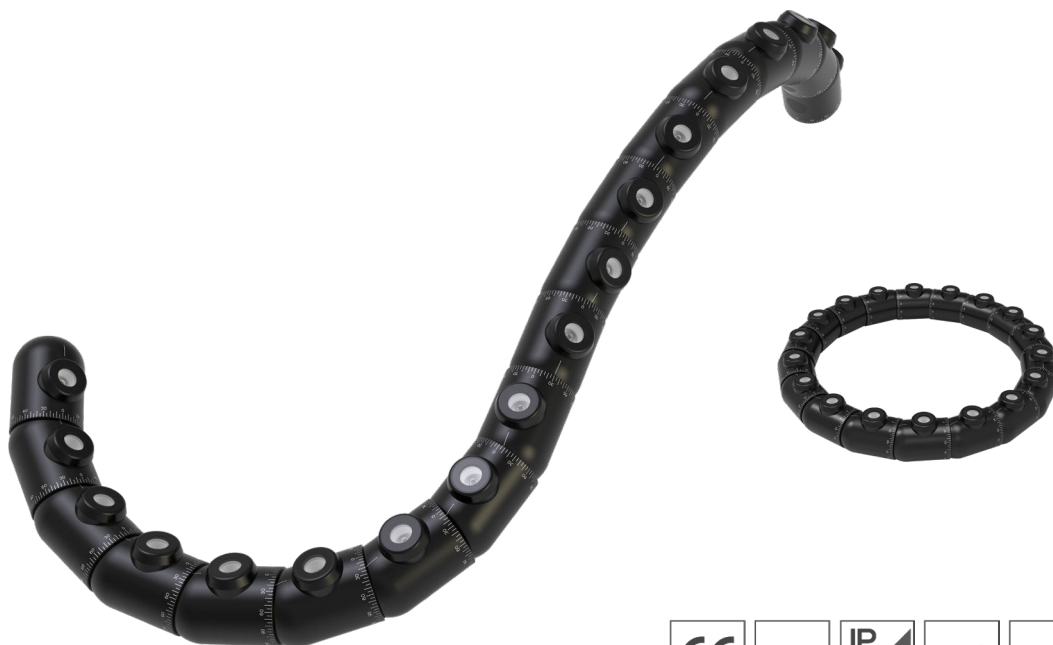

Philips chips, CRI 90
Lens 15° / 25° / 25° x50°



Seamlessly interconnected joints with graduation



Horizontally & Vertically, it can be bent to form nearly any desired curve

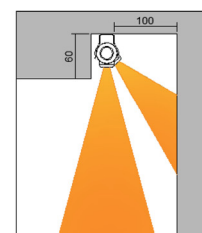
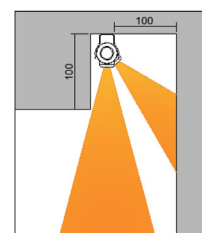
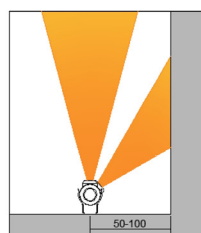
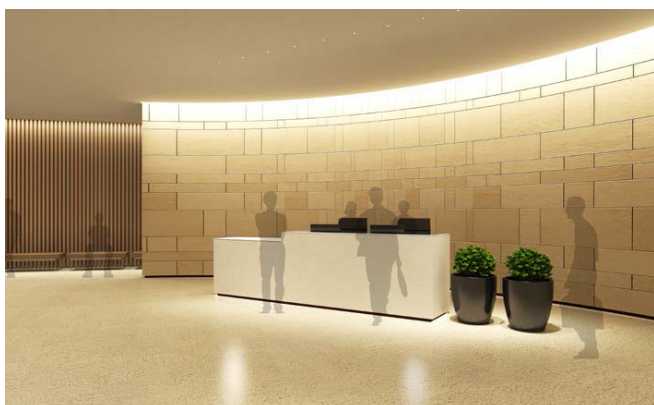

This flexible wallwasher adjusts at multiple points, achieving effects that typically require two or more fixtures, and ensuring seamless integration without obstructing HVAC systems and other ceiling utilities.

Spec guide



- Precision lighting in multiple directions.
- Suitable for specialized and refined settings
- Philips LED chips, CRI 90
- IP67, suitable for indoor and outdoor applications

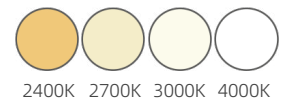
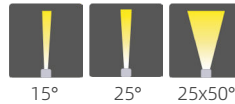
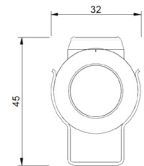
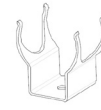
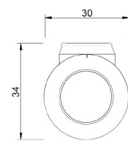

Item No.	Power	Length	Beam Angle	Lumen	Input Current
CL008	15W 30W	L=294mm L=510mm	15° 25° 25x50°	85 lm/W	Constant Current 600mA

Light distribution curve

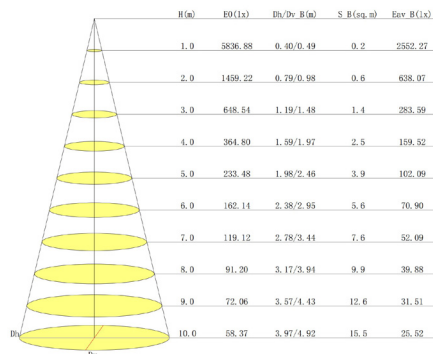
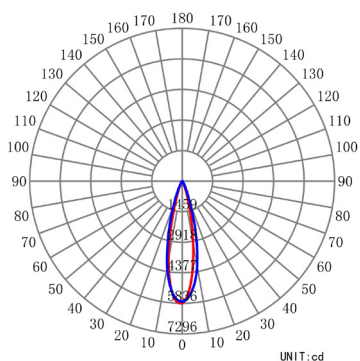

Colour temperature - CRI	IP protection rating	Dimmable	Accessories
2400K - CRI > 90 2700K - CRI > 90 3000K - CRI > 90 4000K - CRI > 90	IP67	Triac PWM 0~10V DALI	

Product Details



CL001 Flexible Linear Light



Philips chips, CRI 90
Lens 15° / 25° / 38° / 25x50°



Seamlessly interconnected joints.



Horizontally, it can be bent to form nearly any desired curve.

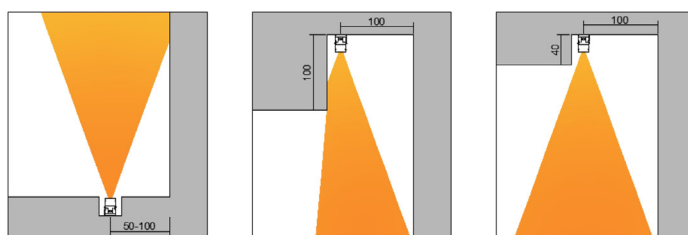

Due to small cross section design, our linear ceiling surface-mounted luminaires offer significant advantages, ensuring seamless integration without obstructing HVAC systems and other ceiling utilities.

Spec guide

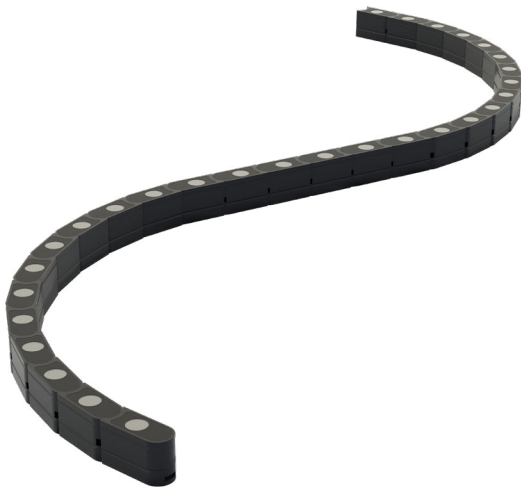

- Tiny size for narrow spaces
- Flexible and bendable design
- Effective wall washing
- Philips LED chips, CRI 90
- Indoor and outdoor applications, IP65 optional

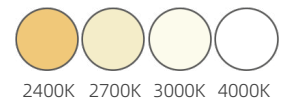
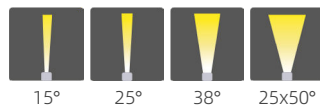
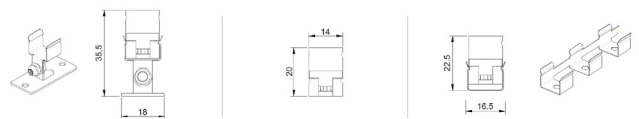

Item No.	Power	Length	Beam Angle	Lumen	Input Current
CL001	8W 12W 24W	L=312mm L=508mm L=1012mm	15° 25° 38° 25x50°	83 lm/W	Constant Current 300mA

Light distribution curve

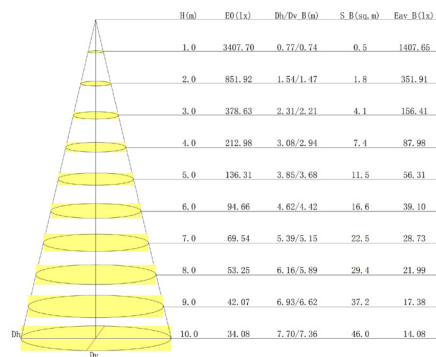
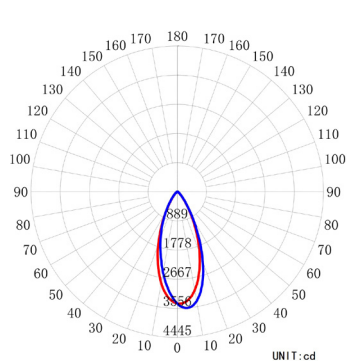

Colour temperature - CRI

- 2400K - CRI > 90
- 2700K - CRI > 90
- 3000K - CRI > 90
- 4000K - CRI > 90

IP protection rating

- IP20
- IP65

Dimmable

- Triac
- PWM
- 0~10V
- DALI

Accessories

Product Details

CL002 Flexible Linear Light

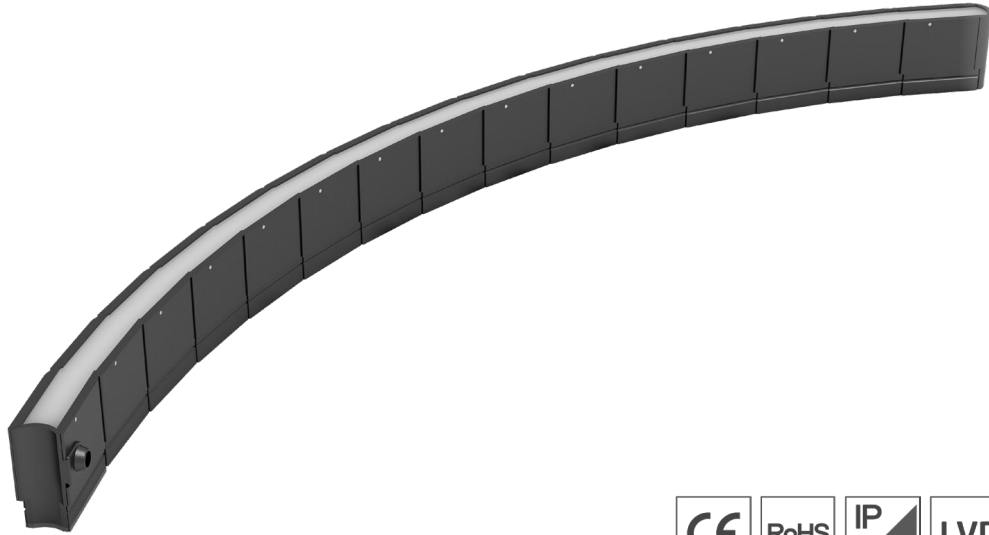

Opal diffuser, shadow-free linear lighting



Seamlessly interconnected joints



Horizontally, it can be bent to form nearly any desired curve

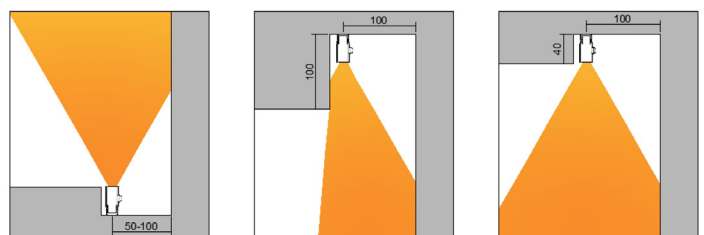

Due to small cross section design, our linear ceiling surface-mounted luminaires offer significant advantages, ensuring seamless integration without obstructing HVAC systems and other ceiling utilities.

Spec guide

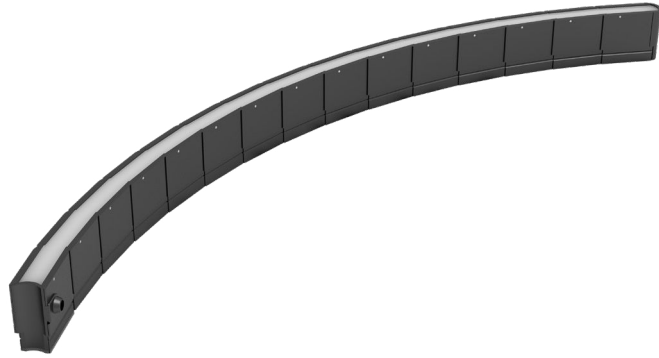

- Flexible & bendable design
- Ideal for wall washing in narrow spaces
- Wall-wash with shadow-free linear lighting
- Philips LED chips, CRI 90
- Indoor and outdoor applications, IP65 optional

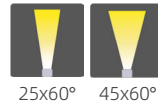
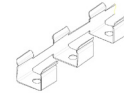
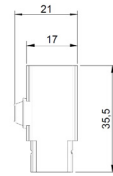

Item No.	Power	Length	Beam Angle	Lumen	Input Voltage
CL002	24W/M	L=313mm L=517mm L=1017mm	25x60° 45x60°	83 lm/W	DC24V

Light distribution curve

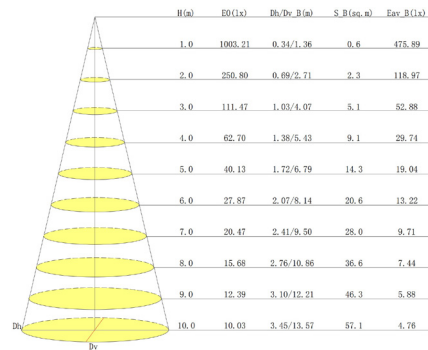
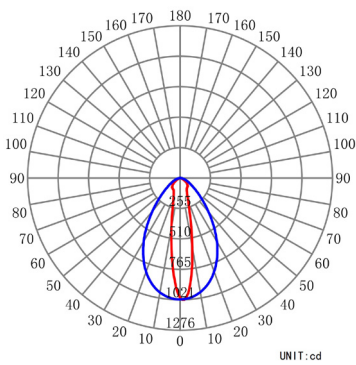

Colour temperature - CRI	IP protection rating	Dimmable	Accessories
2400K - CRI > 90 2700K - CRI > 90 3000K - CRI > 90 4000K - CRI > 90	IP20 IP65	Triac PWM 0~10V DALI	



Product Details

CL003 Flexible Linear Light

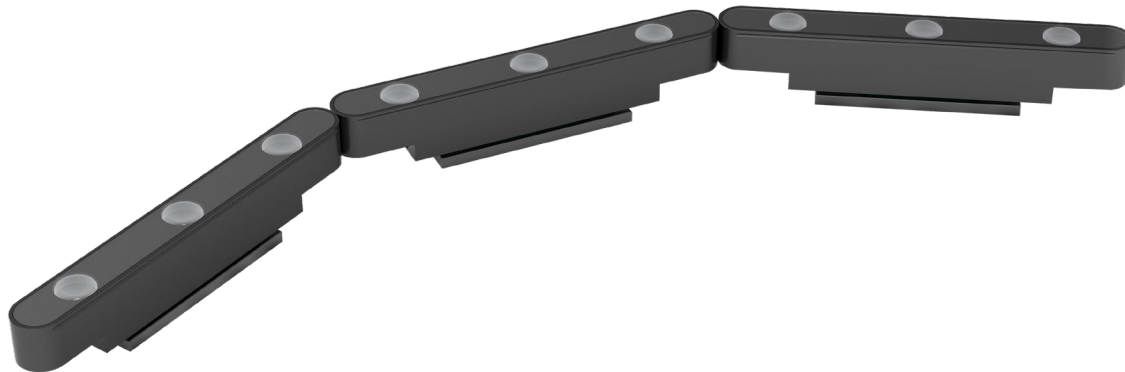

Philips chips, CRI 90
Lens 10° / 25° / 25° x50°



Magnets inside both ends for easy alignment



Quick plug-together design for easy custom lengths

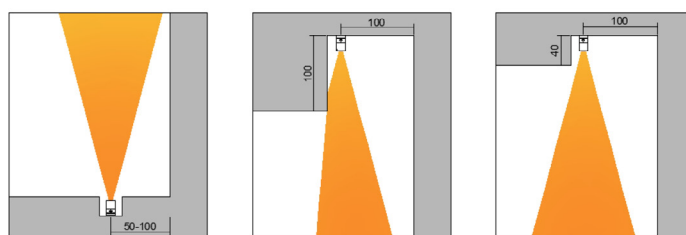

Due to small cross section design, our linear ceiling surface-mounted luminaires offer significant advantages, ensuring seamless integration without obstructing HVAC systems and other ceiling utilities.

Spec guide

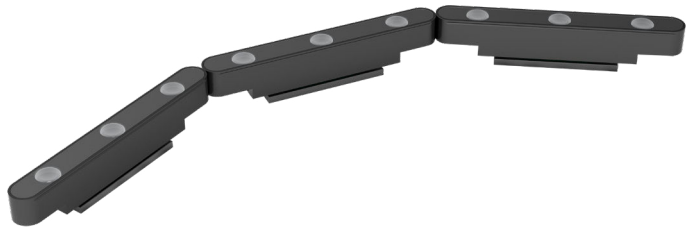

- Tiny size for narrow spaces
- Flexible & bendable design
- Effective wall washing
- Philips LED chips, CRI 90
- Indoor and outdoor applications, IP65 optional

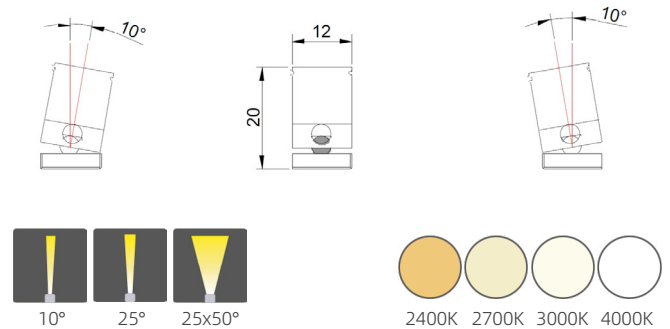

Item No.	Power	Length	Beam Angle	Lumen	Input Voltage
CL003	30W/M	L=100mm L=200mm L=300mm L=600mm L=1000mm	10° 25° 25x50°	100 lm/W	DC12V

Light distribution curve

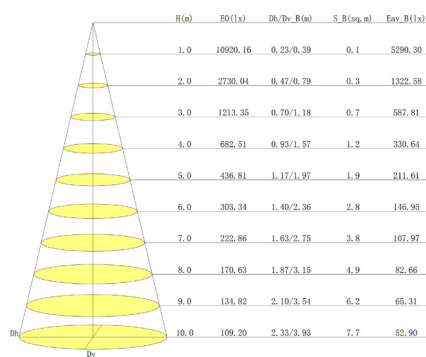
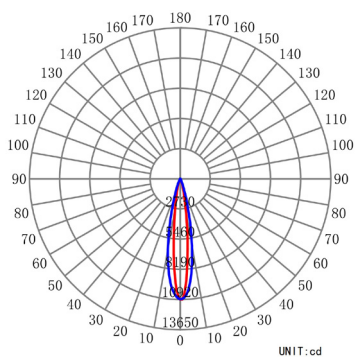

Colour temperature - CRI	IP protection rating	Dimmable	Accessories
2400K - CRI > 90 2700K - CRI > 90 3000K - CRI > 90 4000K - CRI > 90	IP20 IP65	Triac PWM 0~10V DALI	

Product Details

CL004 Flexible Linear Light



Philips chips, CRI 90
Lens 10° / 25° / 25° x50°
Anti-glare shield



Magnets inside both ends for easy alignment



Quick plug-together design for easy custom lengths

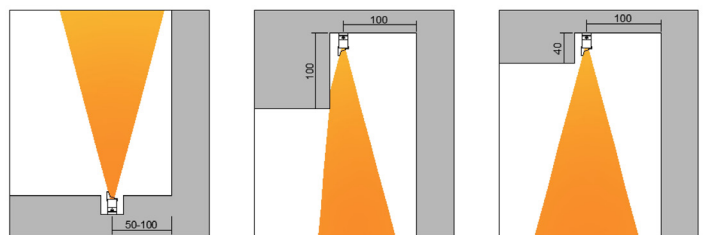
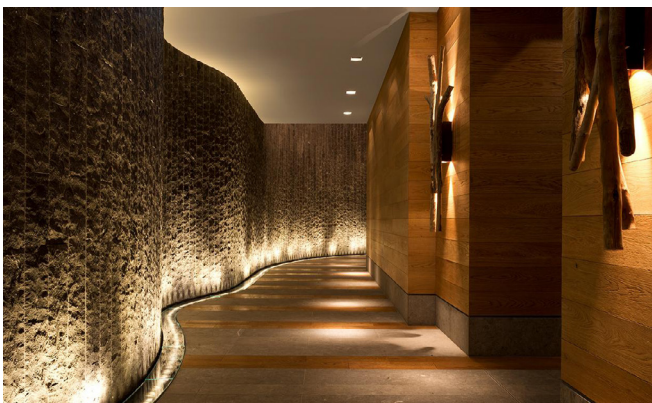

Due to small cross section design, our linear ceiling surface-mounted luminaires offer significant advantages, ensuring seamless integration without obstructing HVAC systems and other ceiling utilities.

Spec guide



- Ideal for wall washing in narrow spaces
- Anti-glare design
- Flexible & bendable design
- Philips LED chips, CRI 90
- Indoor and outdoor applications, IP65 optional

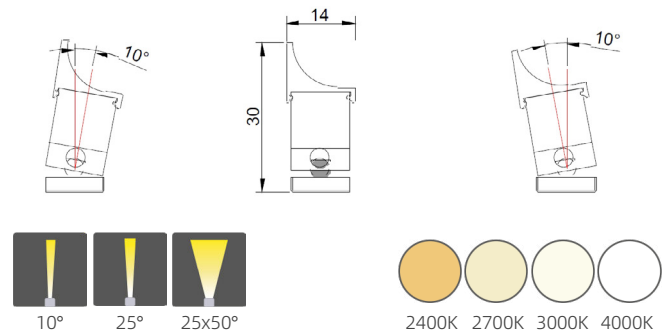

Item No.	Power	Length	Beam Angle	Lumen	Input Voltage
CL004	30W/M	L=100mm L=200mm L=300mm L=600mm L=1000mm	10° 25° 25x50°	100 lm/W	DC12V

Light distribution curve

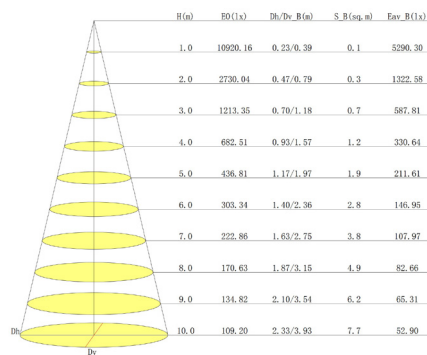
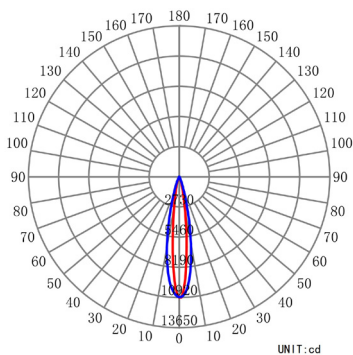

Colour temperature - CRI IP protection rating Dimmable Accessories

2400K - CRI > 90
2700K - CRI > 90
3000K - CRI > 90
4000K - CRI > 90

IP20
IP65

Triac
PWM
0~10V
DALI



Product Details

CL005 Flexible Linear Light



Philips chips, CRI 90
Lens Oval / 10° / 25° / 40°
Anti-glare shield



Sturdy mounting bracket, easy to adjust
installation angles.

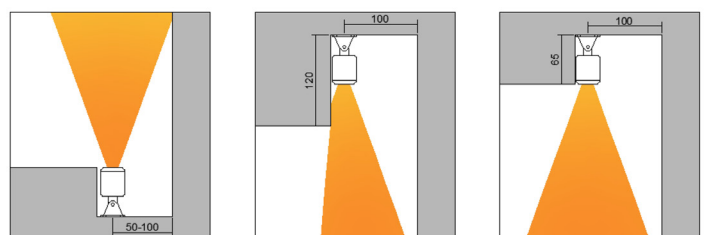
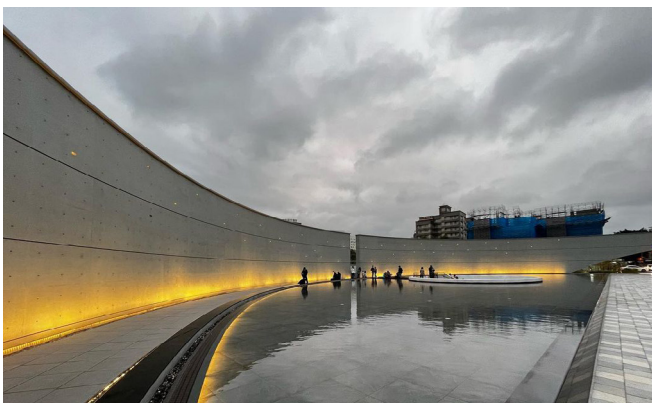

Due to small cross section design, our linear ceiling surface-mounted luminaires offer significant advantages, ensuring seamless integration without obstructing HVAC systems and other ceiling utilities.

Spec guide



- Deep anti-glare design
- Flexible & bendable design
- Effective wall washing
- Philips LED chips, CRI 90
- IP67, suitable for indoor and outdoor applications

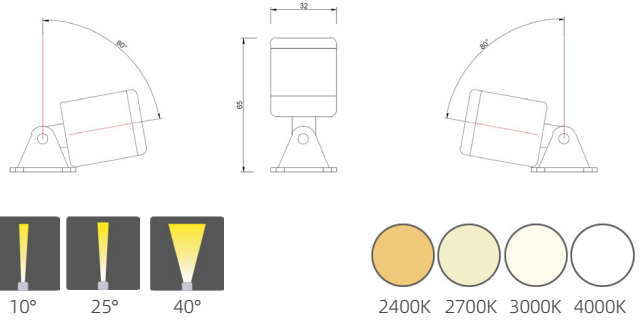

Item No.	Power	Length	Beam Angle/Optics	Lumen	Input Voltage
CL005	30W/M	L=100mm L=200mm L=300mm L=1000mm	10° 25° 40° Oval	88 lm/W	DC24V

Light distribution curve

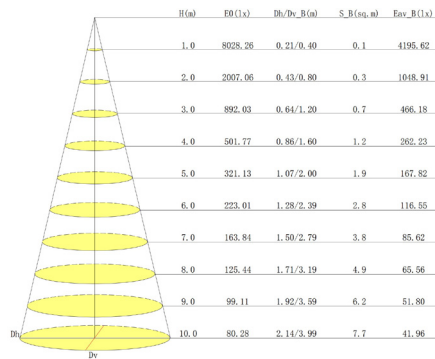
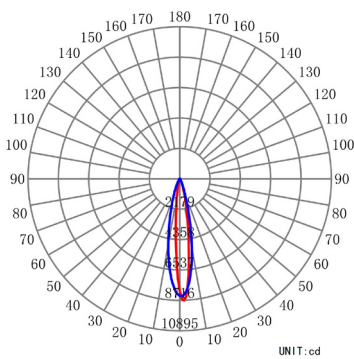

Colour temperature - CRI	IP protection rating	Dimmable	Accessories
--------------------------	----------------------	----------	-------------

2400K - CRI > 90
 2700K - CRI > 90
 3000K - CRI > 90
 4000K - CRI > 90

IP67

Triac
 PWM
 0~10V
 DALI

Product Details



CL006 Flexible Linear Light

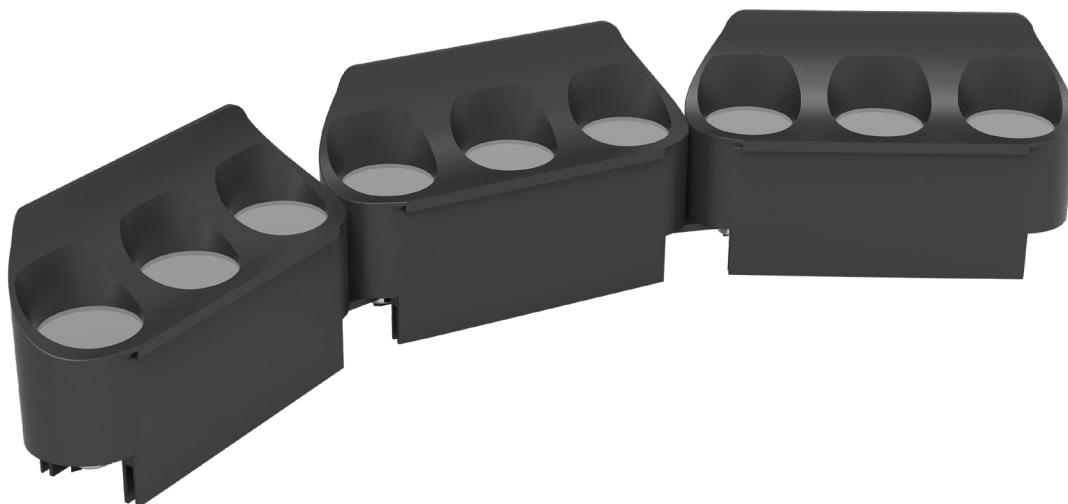

Philips chips, CRI 90
Lens 10° / 20° / 30° / 15° x50°



Sturdy mounting bracket, easy to adjust
installation angles



Anti-glare shield accessory

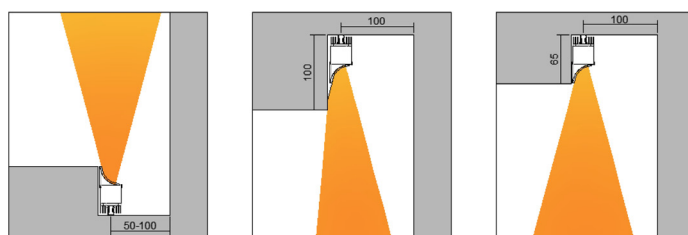

Due to small cross section design, our linear ceiling surface-mounted luminaires offer significant advantages, ensuring seamless integration without obstructing HVAC systems and other ceiling utilities.

Spec guide



- Anti-glare design
- Flexible & bendable design
- Effective wall washing
- Philips LED chips, CRI 90
- Indoor and outdoor applications, IP65 optional

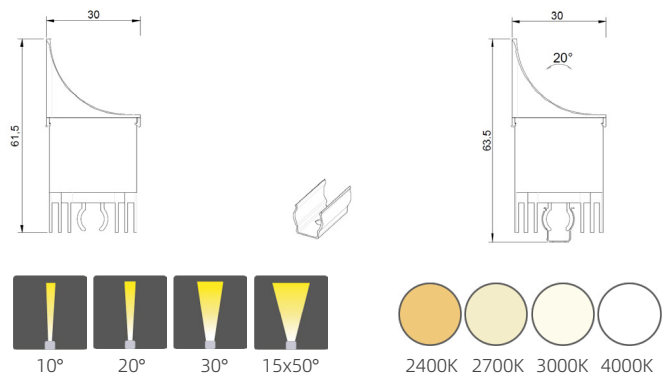
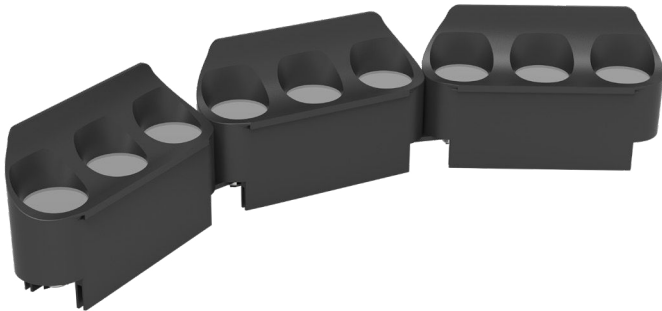

Item No.	Power	Length	Beam Angle	Lumen	Input Voltage
CL006	50W/M	L=200mm L=300mm L=500mm L=1000mm	10° 20° 30° 15x50°	85lm/W	DC24V

Light distribution curve

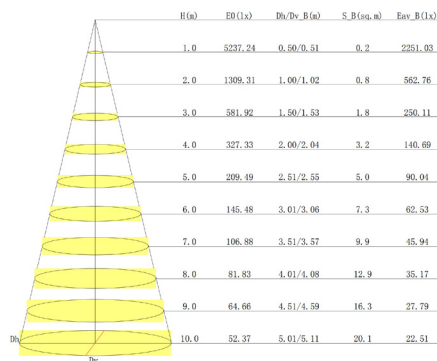
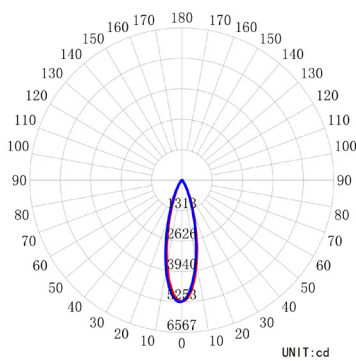

Colour temperature - CRI	IP protection rating	Dimmable	Accessories
2400K - CRI > 90 2700K - CRI > 90 3000K - CRI > 90 4000K - CRI > 90	IP20 IP65	Triac PWM 0~10V DALI	



2019

2019

Product Details

CL021 Flexible Linear Light

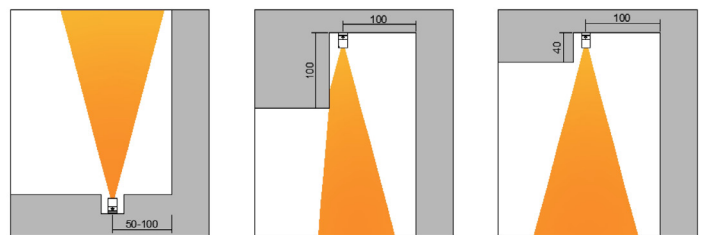

Due to small cross section design, our linear ceiling surface-mounted luminaires offer significant advantages, ensuring seamless integration without obstructing HVAC systems and other ceiling utilities.

Spec guide



- Anti-glare design
- Flexible & bendable design
- Effective wall washing
- SAMSUNG LED chips, CRI 90

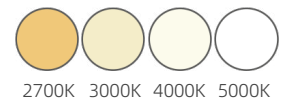
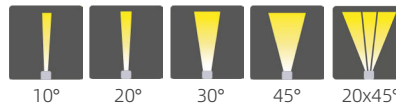
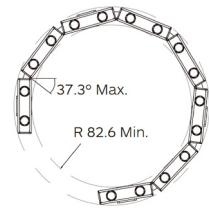
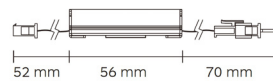
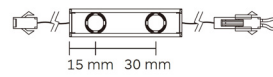

Item No.	Power	Length	Beam Angle	Lumen	Input Voltage
CL021	2W/unit	L=56mm/unit L=1000mm Max	15° 25° 30° 45° 20x45°	210 lm	DC24V

Light distribution curve

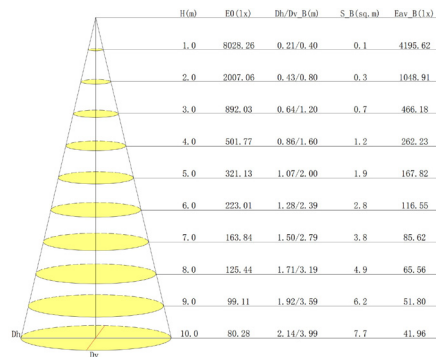
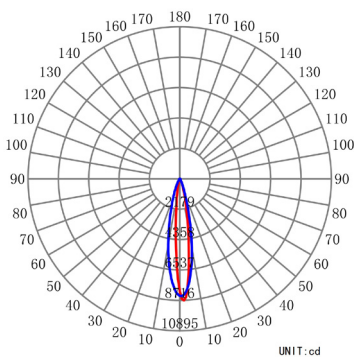

Colour temperature - CRI

- 2700K - CRI > 90
- 3000K - CRI > 90
- 4000K - CRI > 90
- 5000K - CRI > 90

IP protection rating

IP20

Dimmable

- Triac
- PWM
- 0~10V
- DALI

Accessories



Product Details

CL009 Flexible Linear Light

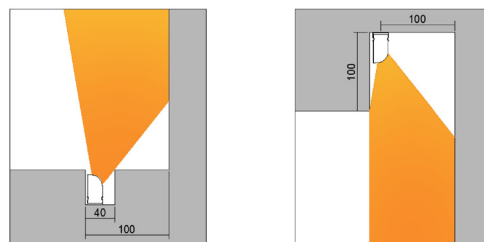

This flexible wallwasher adjusts at multiple points, achieving effects that typically require two or more fixtures, and ensuring seamless integration without obstructing HVAC systems and other ceiling utilities.

Spec guide



- Tiny size for narrow spaces
- Flexible and bendable design
- Effective wall washing
- Philips LED chips, CRI 90

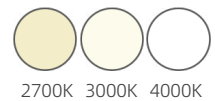
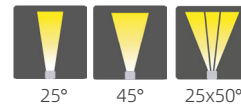
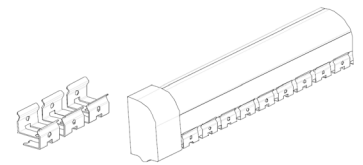
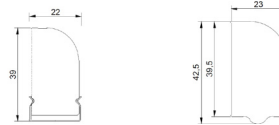

Item No.	Power	Length	Beam Angle	Lumen	Input Current
CL009	20W/M	L=1000mm L=2100mm	25° 45° 25x50°	78 lm/W	DC24V

Light distribution curve

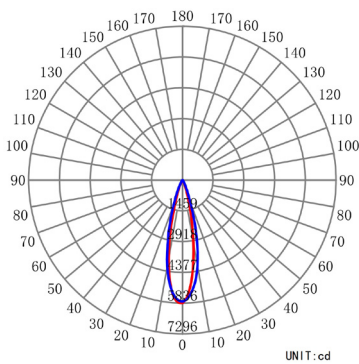

H(m)	FD(lx)	Bh/Dr.B(m)	S.B(sq.m)	Eav.B(lx)
1.0	5836.88	0.40/0.49	0.2	2552.27
2.0	1459.22	0.79/0.98	0.6	638.07
3.0	618.54	1.19/1.48	1.1	283.59
4.0	364.80	1.59/1.97	2.5	159.52
5.0	233.48	1.98/2.46	3.9	102.09
6.0	162.14	2.38/2.95	5.6	70.90
7.0	119.12	2.78/3.44	7.6	52.09
8.0	91.20	3.17/3.94	9.9	39.88
9.0	72.06	3.57/4.43	12.6	31.51
10.0	58.37	3.97/4.92	15.5	25.52

Colour temperature - CRI

- 2700K - CRI > 90
- 3000K - CRI > 90
- 4000K - CRI > 90

IP protection rating

IP67

Dimmable

- Triac
- PWM
- 0~10V
- DALI

Accessories

Product Details

CL010 Flexible Linear Light

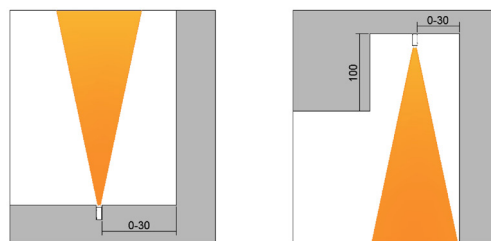
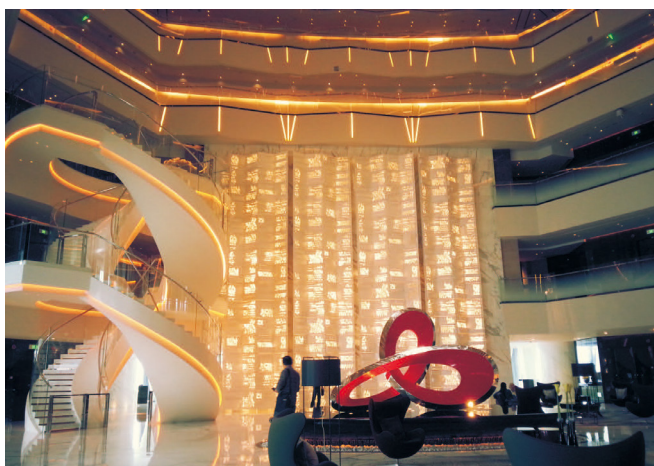
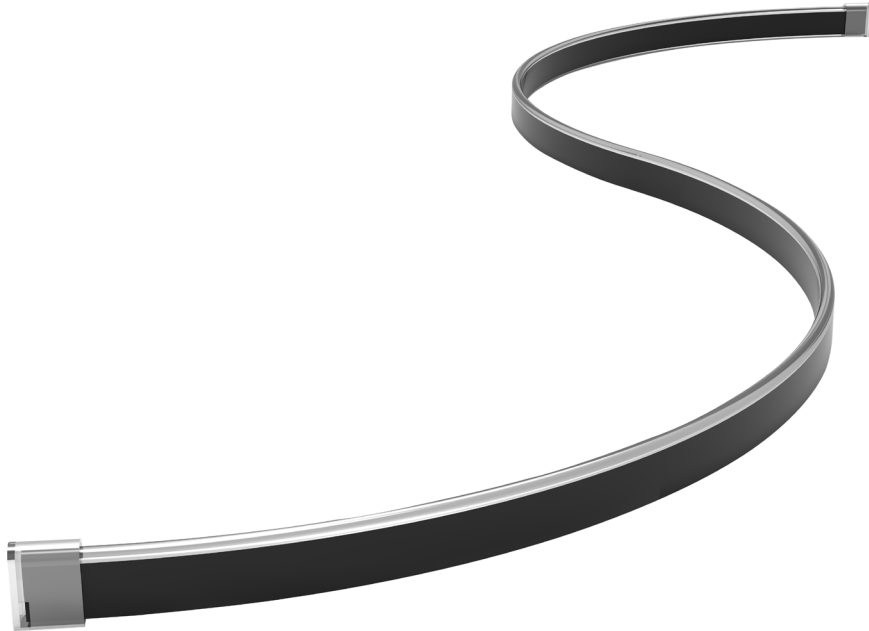

This flexible wallwasher adjusts at multiple points, achieving effects that typically require two or more fixtures, and ensuring seamless integration without obstructing HVAC systems and other ceiling utilities.



Product Details

CL007 Linear Light

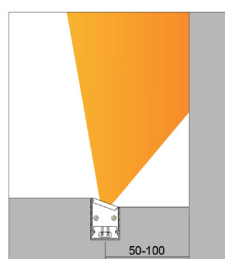
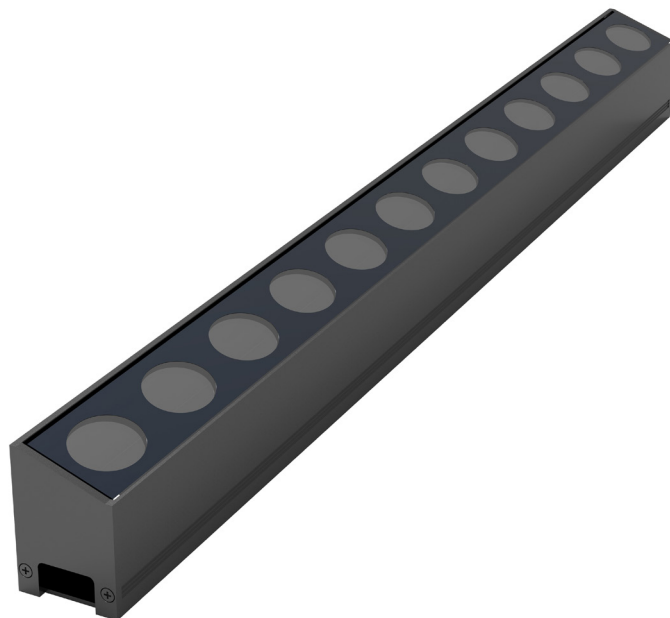

This flexible wallwasher adjusts at multiple points, achieving effects that typically require two or more fixtures, and ensuring seamless integration without obstructing HVAC systems and other ceiling utilities.

Spec guide

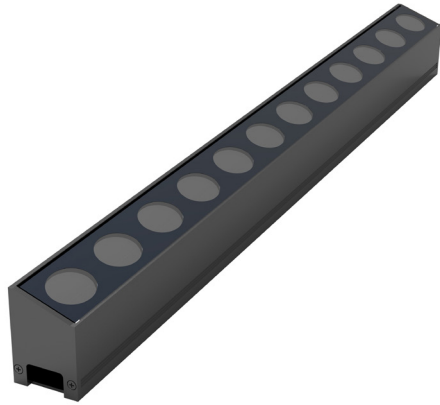

- Dust-resistant slant design
- Effective wall washing
- Ideal choice for premium places
- Philips LED chips, CRI 90
- IP67 for indoor and outdoor applications

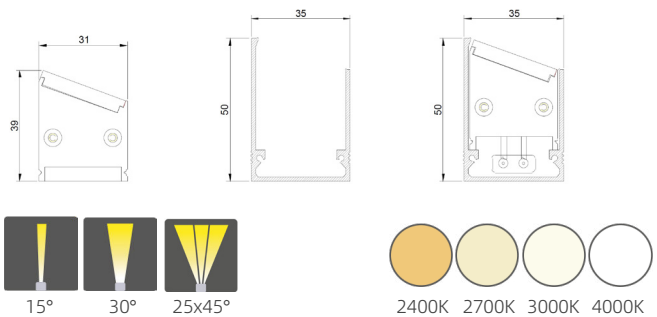

Item No.	Power	Length	Beam Angle	Lumen	Input Current
CL007	15W/M	L=214mm L=300mm L=509mm L=1015mm	15° 30° 25x45°	70 lm/M	DC24V

Light distribution curve

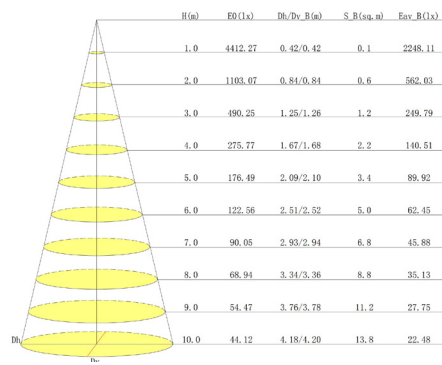
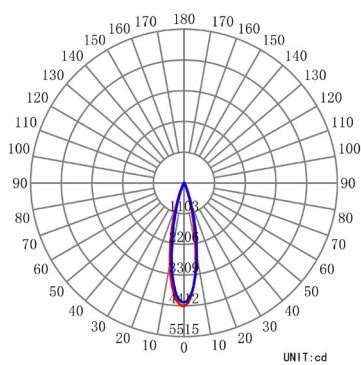

Colour temperature - CRI

- 2400K - CRI > 90
- 2700K - CRI > 90
- 3000K - CRI > 90
- 4000K - CRI > 90

IP protection rating

IP67

Dimmable

- Triac
- PWM
- 0~10V
- DALI

Accessories

Product Details

CL011 Linear Light

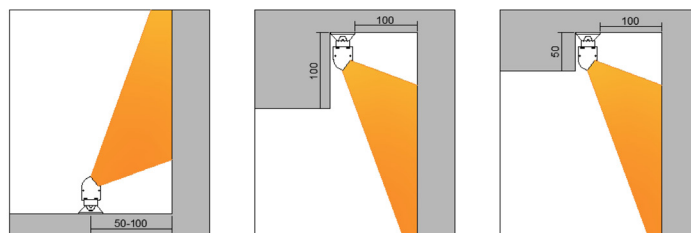

This flexible wallwasher adjusts at multiple points, achieving effects that typically require two or more fixtures, and ensuring seamless integration without obstructing HVAC systems and other ceiling utilities.

Spec guide



- Deep anti-glare
- Effective wall washing
- Philips LED chips, CRI 90
- IP67 for indoor and outdoor applications

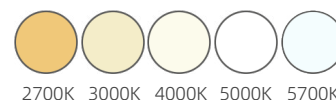
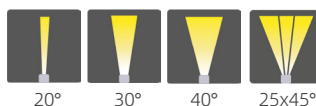
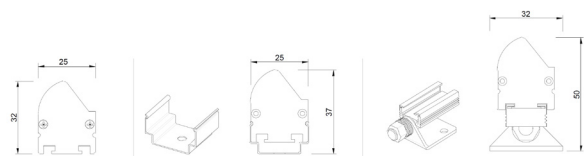

Item No.	Power	Length	Beam Angle	Lumen	Input Current
CL011	30W/M	L=200mm L=300mm L=500mm L=1000mm	20° 30° 40° 25x50°	70 lm/W	DC24V

Light distribution curve

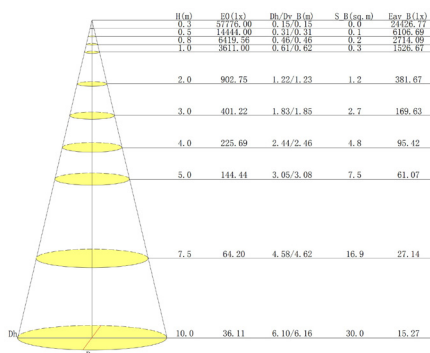
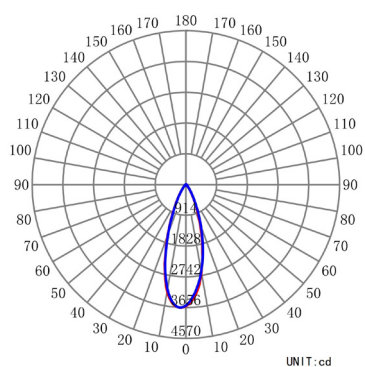

Colour temperature - CRI

- 2700K - CRI > 90
- 3000K - CRI > 90
- 4000K - CRI > 90
- 5000K - CRI > 90
- 5700K - CRI > 90

IP protection rating

IP67

Dimmable

- Triac
- PWM
- 0~10V
- DALI

Accessories

Product Details

CL012 Linear Light

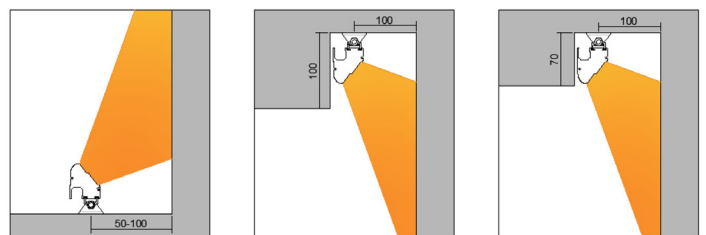

This flexible wallwasher adjusts at multiple points, achieving effects that typically require two or more fixtures, and ensuring seamless integration without obstructing HVAC systems and other ceiling utilities.

Spec guide



- Deep anti-glare
- Effective wall washing
- Philips LED chips, CRI 90
- IP67 for indoor and outdoor applications

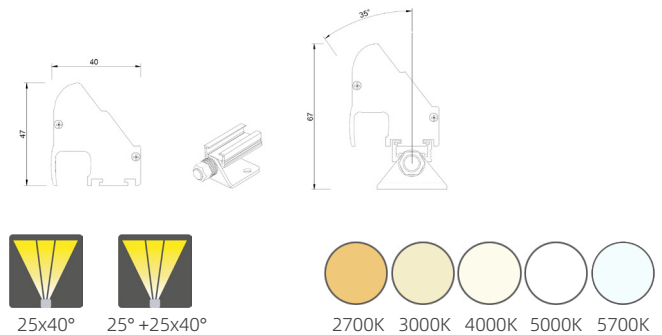

Item No.	Power	Length	Beam Angle	Lumen	Input Current
CL012	60W/M	L=200mm L=300mm L=500mm L=1000mm	25° +40° 25° +25° x45°	70 lm/W	DC24V

Light distribution curve

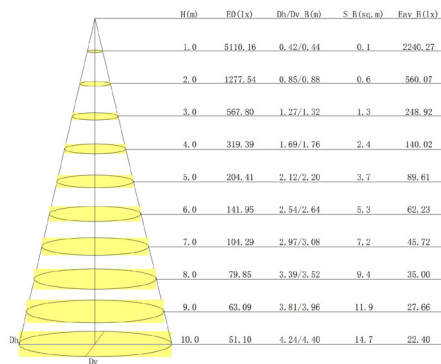
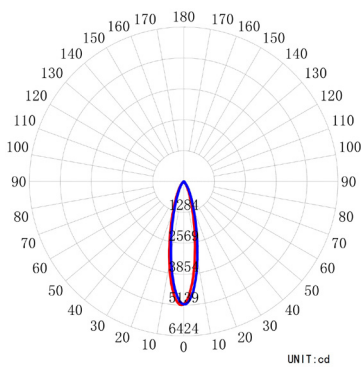

Colour temperature - CRI

- 2700K - CRI > 90
- 3000K - CRI > 90
- 4000K - CRI > 90
- 5000K - CRI > 90
- 5700K - CRI > 90

IP protection rating

IP67

Dimmable

- Triac
- PWM
- 0~10V
- DALI

Accessories

Product Details

CL013 Linear Light

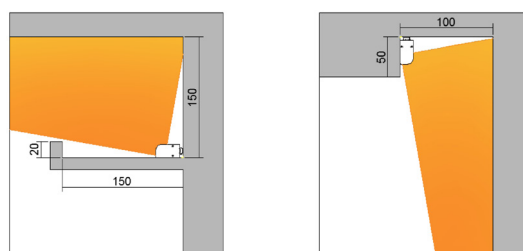
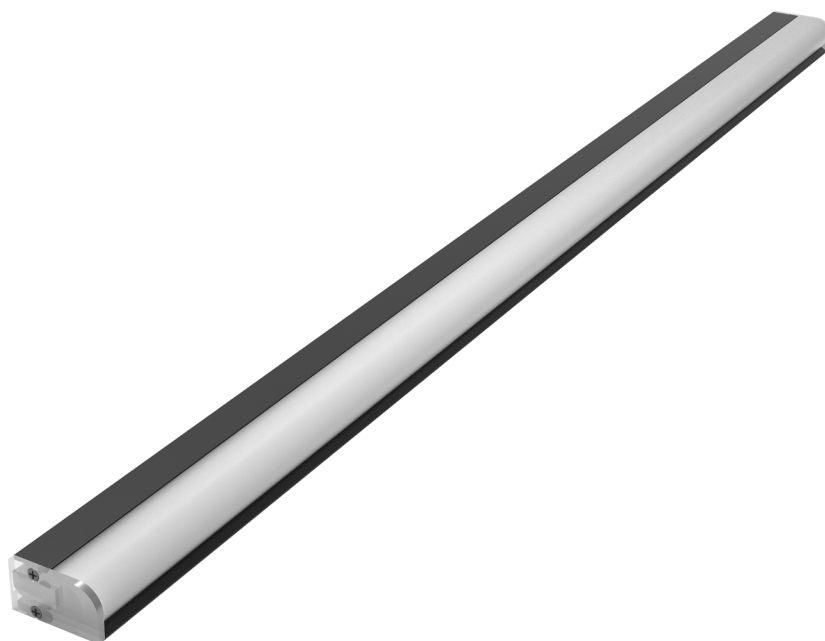

This flexible wallwasher adjusts at multiple points, achieving effects that typically require two or more fixtures, and ensuring seamless integration without obstructing HVAC systems and other ceiling utilities.

Spec guide



- Linear lens and even lighting
- Effective wall washing
- Philips LED chips, CRI 90

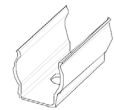
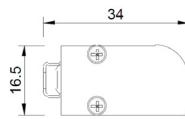

70° Asymmetry



2400K 2700K 3000K 4000K 5600K

Item No.	Power	Length	Beam Angle	Lumen	Input Current
CL013	30W/M	L=1000mm	70° Asymmetry	85 lm/W	DC24V

Light distribution curve

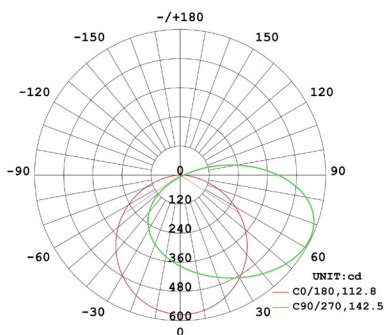

Colour temperature - CRI	IP protection rating	Dimmable	Accessories
2400K - CRI > 90 2700K - CRI > 90 3000K - CRI > 90 4000K - CRI > 90 5600K - CRI > 90	IP20	Triac PWM 0~10V DALI	

Product Details

CL014 Linear Light

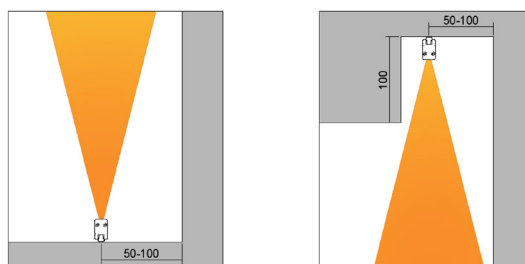
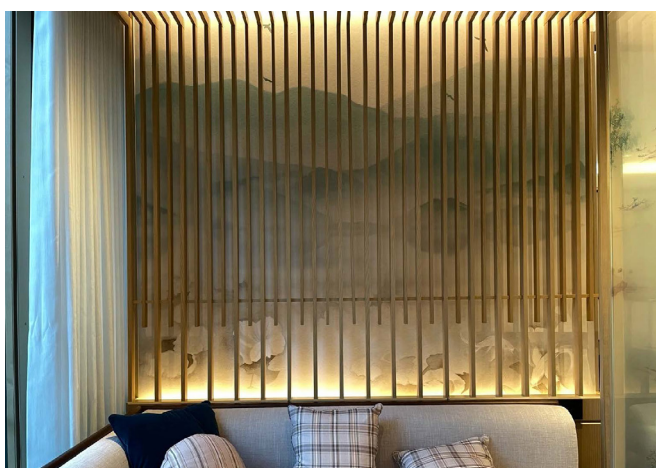

This flexible wallwasher adjusts at multiple points, achieving effects that typically require two or more fixtures, and ensuring seamless integration without obstructing HVAC systems and other ceiling utilities.

Spec guide



- Linear lens and even lighting
- Effective wall washing
- Philips LED chips, CRI 90

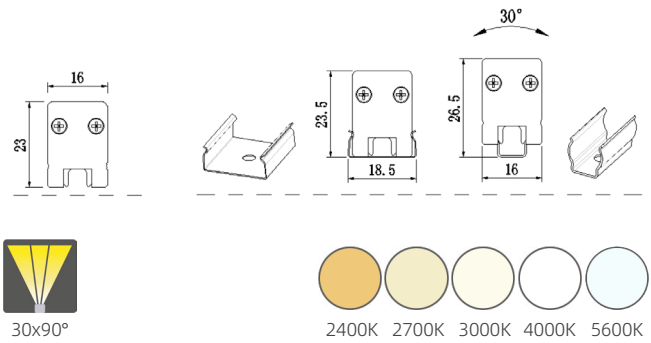

Item No.	Power	Length	Beam Angle	Lumen	Input Current
CL014	20W/M	L=1005mm	30x90°	80lm/W	DC24V

Light distribution curve

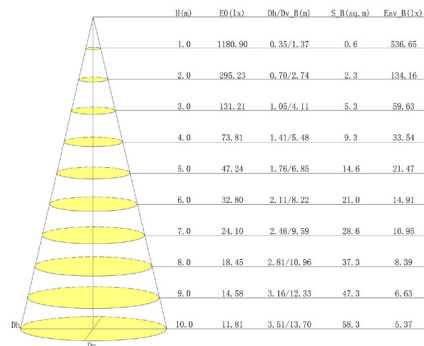
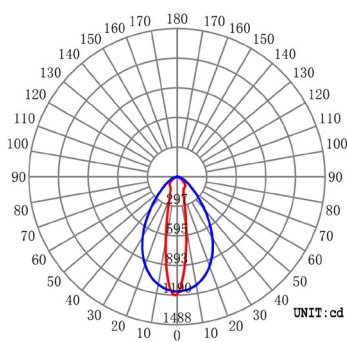

Colour temperature - CRI

- 2400K - CRI > 90
- 2700K - CRI > 90
- 3000K - CRI > 90
- 4000K - CRI > 90
- 5600K - CRI > 90

IP protection rating

IP20

Dimmable

- Triac
- PWM
- 0~10V
- DALI

Accessories

Product Details

CL018 Linear Light

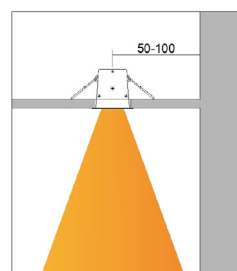
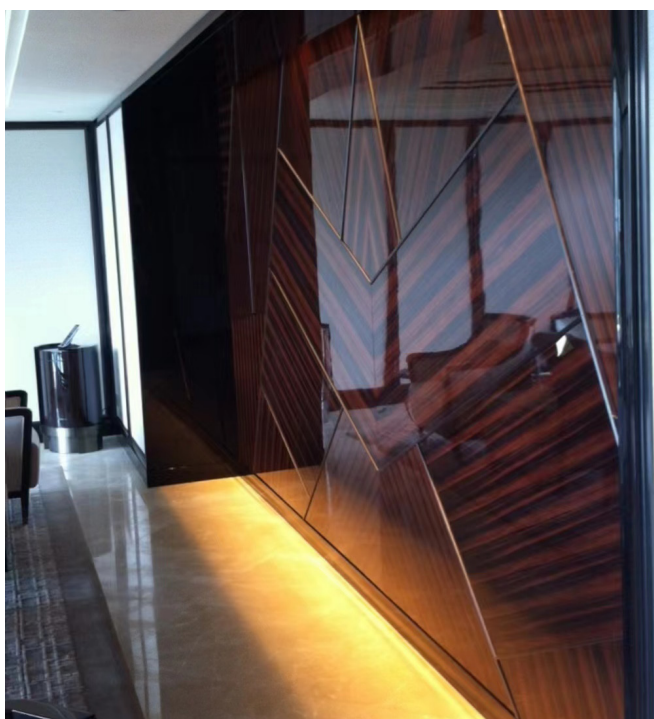

This flexible wallwasher adjusts at multiple points, achieving effects that typically require two or more fixtures, and ensuring seamless integration without obstructing HVAC systems and other ceiling utilities.

Spec guide



- Deep anti-glare
- Effective wall washing
- Philips LED chips, CRI 90

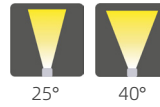
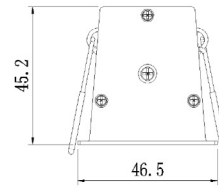

Item No.	Power	Length	Beam Angle	Lumen	Input Current
CL018	30W/M	L=217mm L=615mm	25° 40° Oval	70 lm/W	DC24V

Light distribution curve

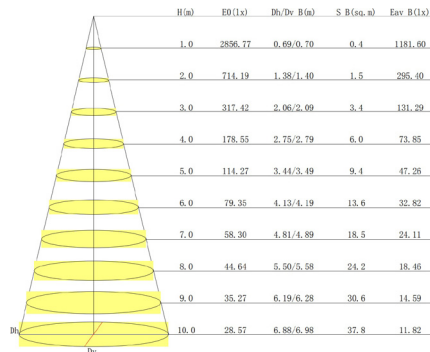
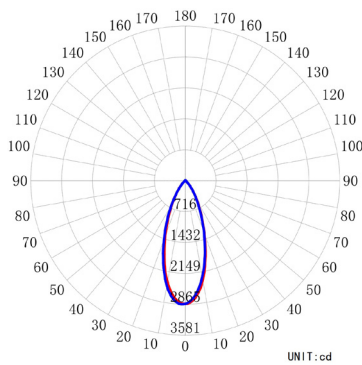

Colour temperature - CRI

- 2400K - CRI > 90
- 2700K - CRI > 90
- 3000K - CRI > 90
- 4000K - CRI > 90

IP protection rating

IP20

Dimmable

- Triac
- PWM
- 0~10V
- DALI

Accessories

Product Details

CL019 Linear Light

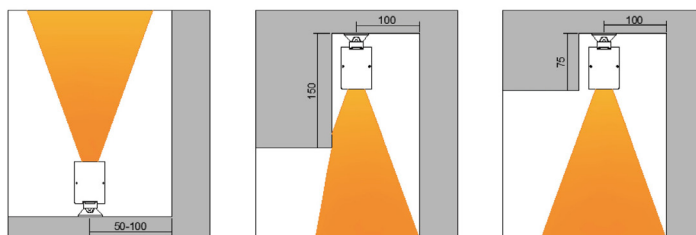
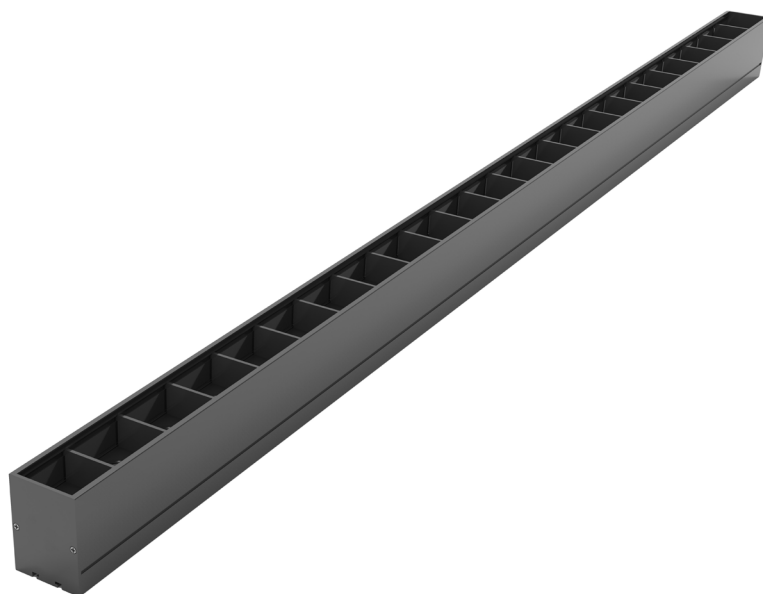

This flexible wallwasher adjusts at multiple points, achieving effects that typically require two or more fixtures, and ensuring seamless integration without obstructing HVAC systems and other ceiling utilities.

Spec guide



- Deep anti-glare
- Effective wall washing
- Philips LED chips, CRI 90

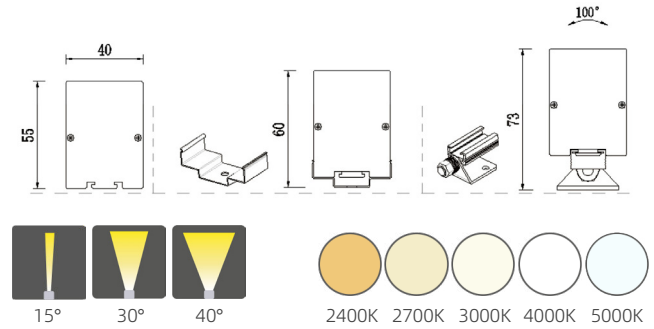

Item No.	Power	Length	Beam Angle	Lumen	Input Current
CL019	56W/M	L=200mm L=300mm L=500mm L=1000mm	15° 30° 40°	90 lm/W	DC24V

Light distribution curve

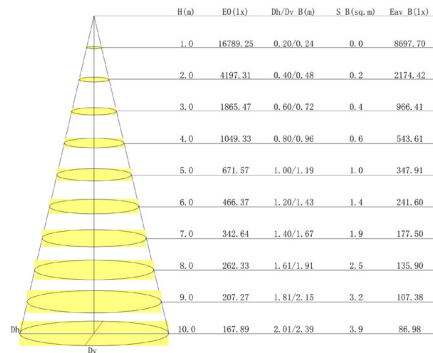
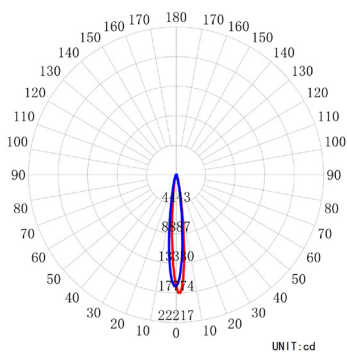

Colour temperature - CRI	IP protection rating	Dimmable	Accessories
2400K - CRI > 90 2700K - CRI > 90 3000K - CRI > 90 4000K - CRI > 90 5000K - CRI > 90	IP20	Triac PWM 0~10V DALI	

Product Details

CL020 Linear Light

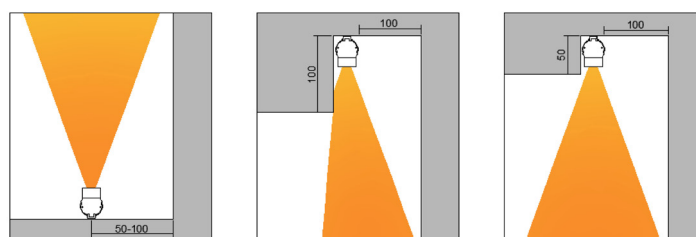
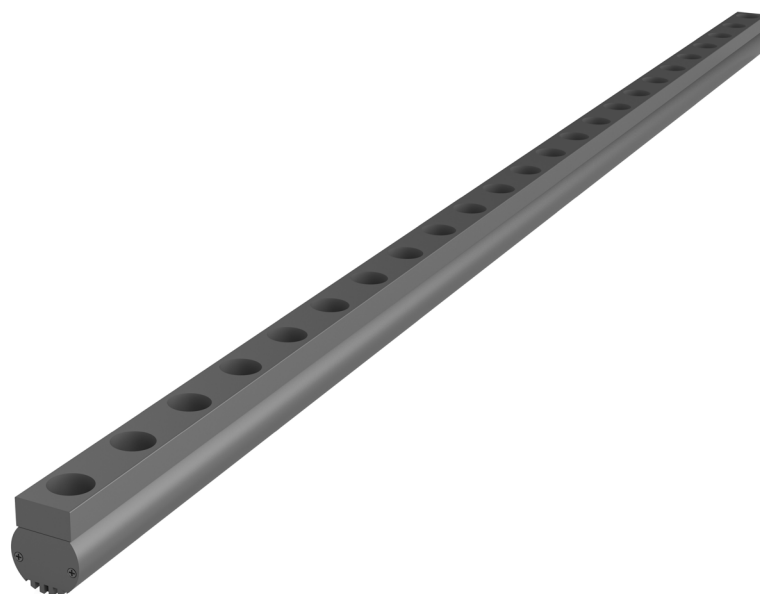

This flexible wallwasher adjusts at multiple points, achieving effects that typically require two or more fixtures, and ensuring seamless integration without obstructing HVAC systems and other ceiling utilities.

Spec guide

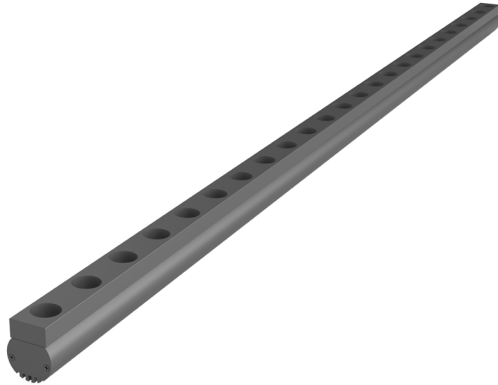

- Unique design
- Deep anti-glare
- Effective wall washing
- Philips LED chips, CRI 90

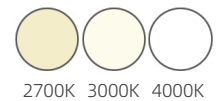
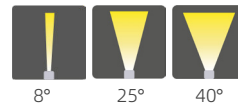
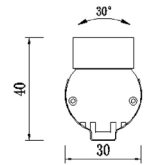
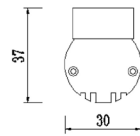

Item No.	Power	Length	Beam Angle	Lumen	Input Current
CL020	4.8W/0.2M 7.2W/0.3M 12W/0.5M	L=200mm L=300mm L=500mm	8° 25° 40°	65 lm/W	DC24V

Light distribution curve

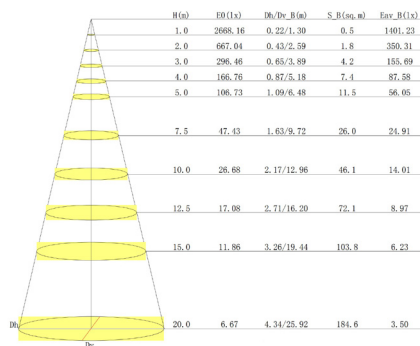
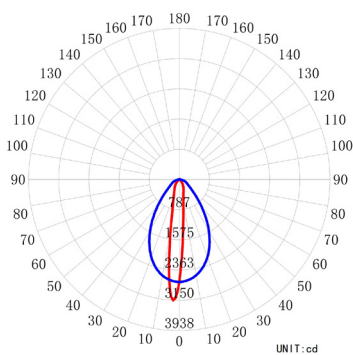

Colour temperature - CRI

2700K - CRI > 90
3000K - CRI > 90
4000K - CRI > 90

IP protection rating

IP20

Dimmable

Triac
PWM
0~10V
DALI

Accessories

Product Details

CL016 Linear Light

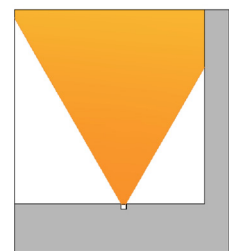
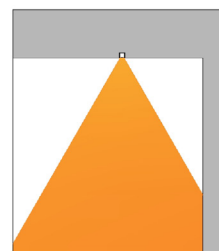
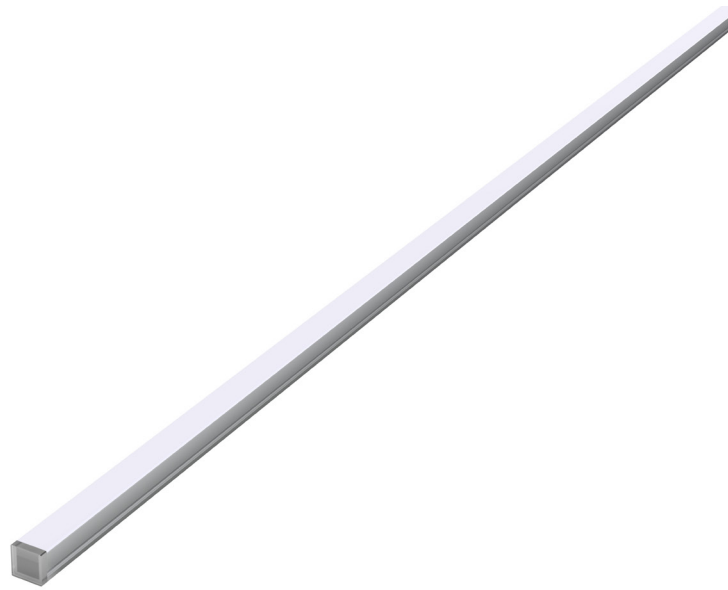

Spec guide

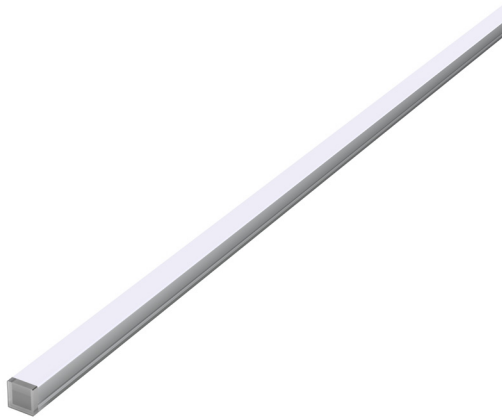

- Tiny size for narrow spaces
- Philips LED chips, CRI 90

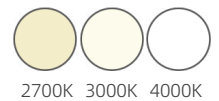
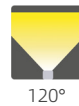
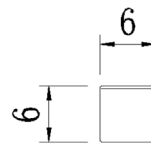

Item No.	Power	Length	Beam Angle	Lumen	Input Current
CL016	10W/M	L=1010mm	120°	70 lm/W	DC24V

Light distribution curve

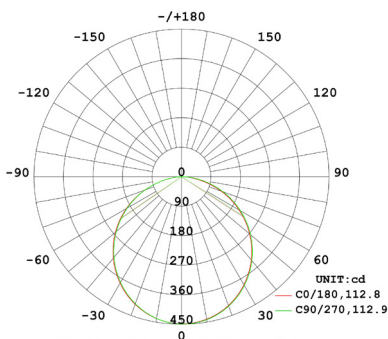

Colour temperature - CRI	IP protection rating	Dimmable	Accessories
2700K - CRI > 90 3000K - CRI > 90 4000K - CRI > 90	IP20	Triac PWM 0~10V DALI	

Product Details

CL017 Linear Light

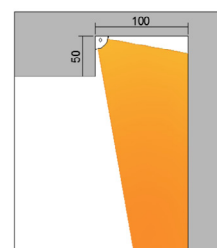
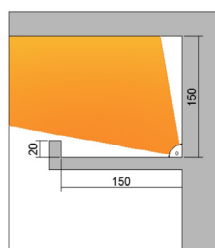
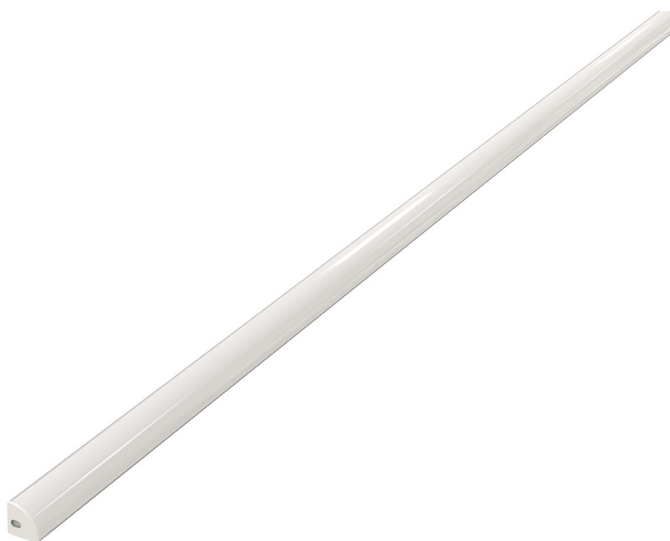

This flexible wallwasher adjusts at multiple points, achieving effects that typically require two or more fixtures, and ensuring seamless integration without obstructing HVAC systems and other ceiling utilities.

Spec guide



- Tiny size for narrow spaces
- Philips LED chips, CRI 90

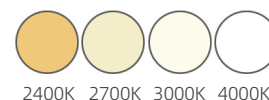
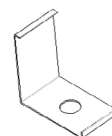
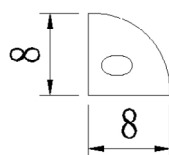

Item No.	Power	Length	Beam Angle	Lumen	Input Current
CL017	10W/M	L=1005mm	120°	80lm/W	DC24V

Light distribution curve

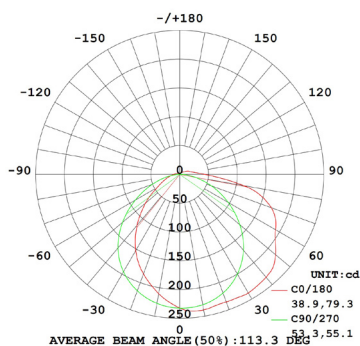

Colour temperature - CRI	IP protection rating	Dimmable	Accessories
2400K - CRI > 90 2700K - CRI > 90 3000K - CRI > 90 4000K - CRI > 90	IP20	Triac PWM 0~10V DALI	

Product Details

CL023 Linear Light

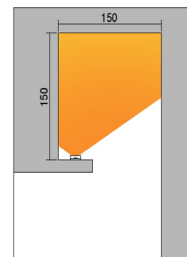
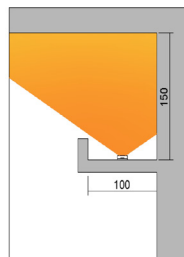
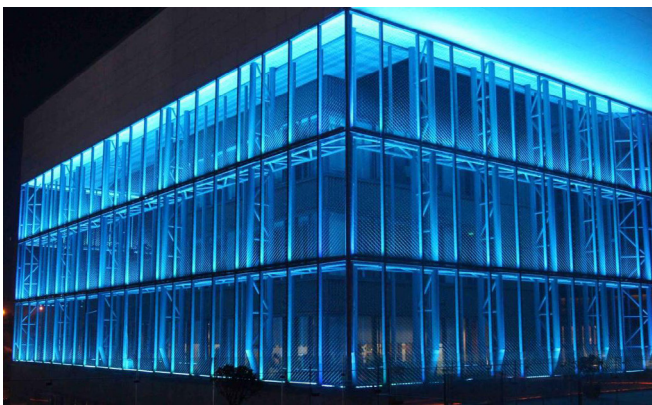

Spec guide



- Tiny size for narrow spaces

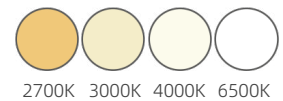
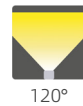
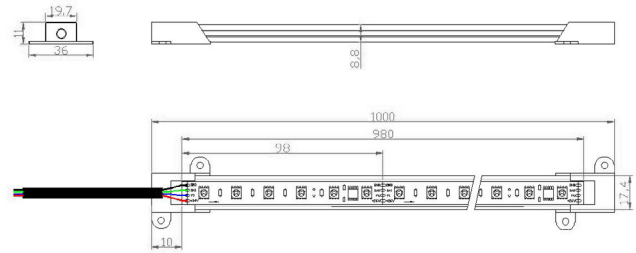

Item No.	Power	Length	Beam Angle	Lumen	Input Current
CL023	10W/M	L=1000mm	120°	100 lm/M	DC24V

Light distribution curve

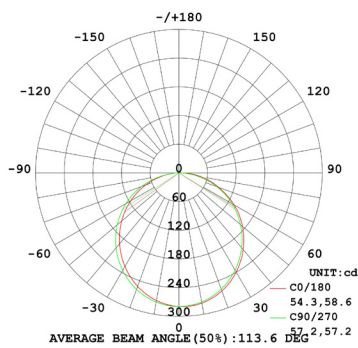

Colour temperature - CRI	IP protection rating	Dimmable	Accessories
2700K - CRI > 90 3000K - CRI > 90 4000K - CRI > 90 6500K - CRI > 90	IP67	Triac PWM 0~10V DALI	

Product Details



CL022 Flexible Linear Light

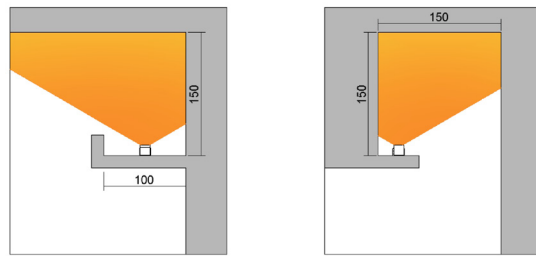

This flexible wallwasher adjusts at multiple points, achieving effects that typically require two or more fixtures, and ensuring seamless integration without obstructing HVAC systems and other ceiling utilities.

Accessories

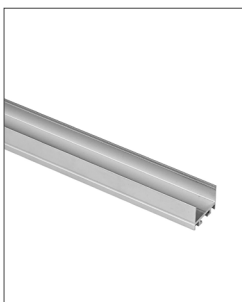

Standard aluminum profile



Anti-glare aluminum profile

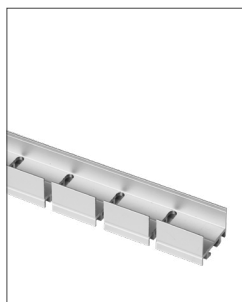

Bendable aluminum profile

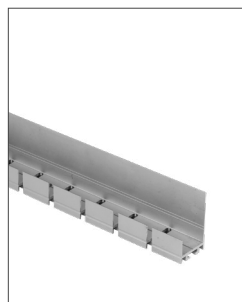

Anti-glare & bendable aluminum profile



Profile bracket

Spec guide



- Flexible and bendable design
- Vertically and horizontally bendable
- Effective wall washing
- SANAN LED chips, CRI 90
- IP68 for underwater applications

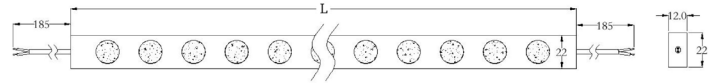

Item No.	Power	Length	Beam Angle	Lumen	Input Current
CL022	18W/M	L=1000mm L=5000mm Max	15° 30° 45° 10x30°	75 lm/W	DC24V

Light distribution curve

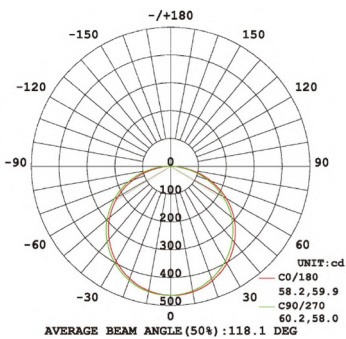

Colour temperature - CRI	IP protection rating	Dimmable	Accessories
2700K - CRI > 90 3000K - CRI > 90 4000K - CRI > 90 6500K - CRI > 90	IP68	Triac PWM 0~10V DALI	

Product Details

CL015 Flexible Linear Light

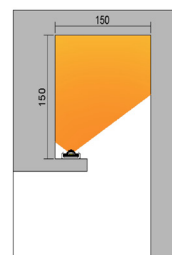
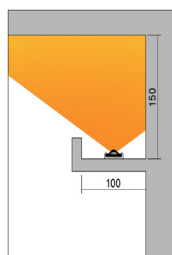
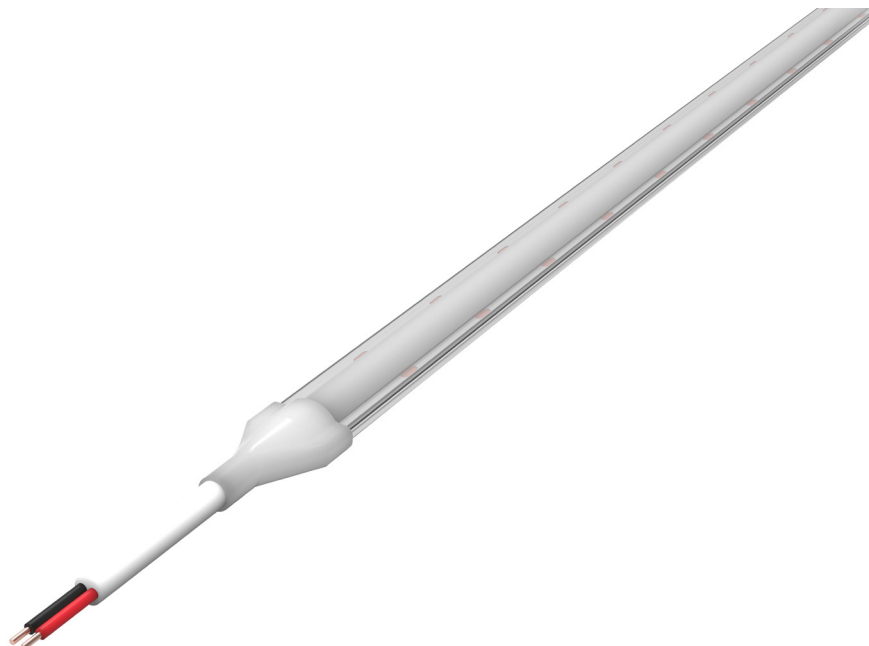

Spec guide

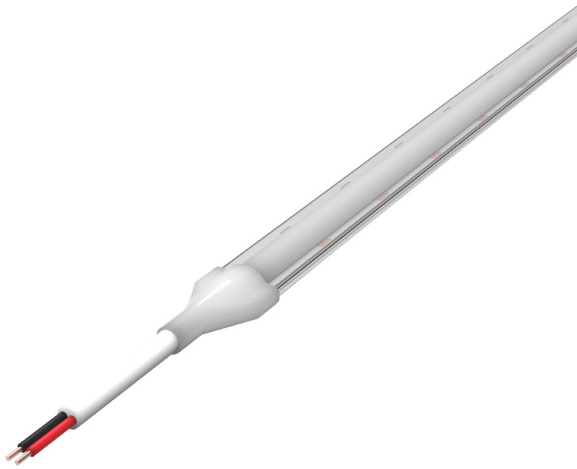

- Flexible and bendable design
- Philips LED chips, CRI 90
- IP67 for indoor and outdoor applications

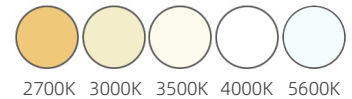
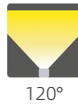
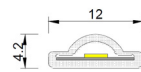

Item No.	Power	Length	Beam Angle	Lumen	Input Current
CL015	12W/M	L=1064mm L=5000mm Max	120°	88 lm/W	DC24V

Light distribution curve

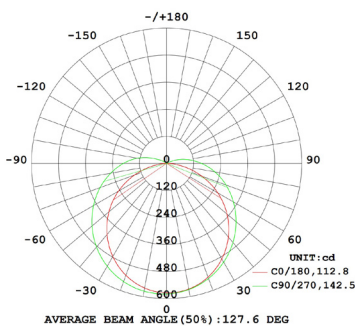

Colour temperature - CRI	IP protection rating	Dimmable	Accessories
2700K - CRI > 90 3000K - CRI > 90 3500K - CRI > 90 4000K - CRI > 90 5600K - CRI > 90	IP67	Triac PWM 0~10V DALI	

Environmental Commitment

Using recycled luminaire material and packaging against environment pollution. We are dedicated to reducing our environmental impact and continually improving our performance in this regard. Our commitment is integrated into our business strategy and operational procedures, with regular reviews. We also encourage our customers, suppliers, and stakeholders to embrace environmentally responsible practices. As part of our pledge, we aim to enhance our environmental footprint by utilizing eco-friendly products and processes, always placing the customer and the environment at the forefront. We are unwavering in our pursuit of this mission





Laclite is brand for high standard project from Lacelesty Lighting

Huizhou Lacelesty lighting Co.,LTD, established in 2017, as a professional indoor and outdoor lighting solution provider, we bring the possibility to our clients.

Lacelesty lighting is providing the products including LED Wallwasher, Spot Light, Bollard Light, Wall Light, Step Light, Inground Light, Handrail Light, linear light and accessories. It creates as much as design options. Moreover, custom-made LED products to meet the local market special needs by multiple lighting distribution, multi-function control system, different finishing of treatment. Our comprehensive range of products makes a "one stop solutions". Each product and package under strict quality control from material to completed unit, Lacelesty focus on premium and Humanized design concept product, we aim to make unique, durable and affordable lights to benefit your projects by our professionals.

Lacelesty will bring you professional solution, superior product and in-time shipment.

Welcome to contact with us for any inquiries. Lacelesty is more than a lighting supplier but your partner.

 :+86-15976184094

 :la@lacelesty.com



WeChat



WhatsApp

Coastline